

Linear

LINI-R XL A040 (40W)

Fixture Guide

KKDC

Indoor | Recessed | Output up to 2000lm/m (610lm/ft)



Key applications

- ✓ Architectural detail
- ✓ Ceiling
- ✓ Direct lighting
- ✓ Downlighting
- ✓ Interior

Key features

- ✓ A-line (High Efficacy)
- ✓ Custom lengths
- ✓ Constant Voltage (CV)
- ✓ Diffusion: homogenous
- ✓ Direct view
- ✓ Extensive CCT range
- ✓ High lumen efficacy
- ✓ IP40 dry area

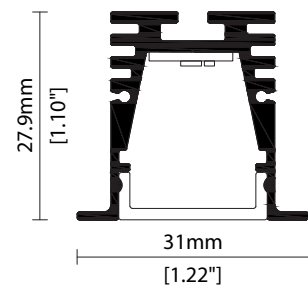

Linear

LINE-R XL A040 (40W)

Specification sheet



Dimensions	H27.9/W31/L93-1516mm (H1.10/W1.22/L3.66-59.68in) (excluding spring clips)
PCB Cut-point	38.46mm increment/1500mm max (1.51in increment/59.06in max)
LED Pitch	4.8mm - 208LED/m (0.19in - 64LED/ft)
Chip	A-line
Cover/Optics	Diffused (110°)
CCT	A-line: 2700K/3000K/3500K/4000K
LED binning	A-line: 3-step MacAdam ellipse
CRI	94
Lifetime	50,000 hours @ 25°C (50,000 hours @ 77°F)
Operating temp	T _a = -25 to 50°C (T _c max = 89.1°C) T _a = -13 to 104°F (T _c max = 192.4°F)
IP Rating	IP40
Finish	Silver anodised
Mounting	Recessed mounting via spring clip
Power feed	Hardwire tails or male/female connectors
Control	0-10V/1-10V/DMX/DALI



LED Grading Key

Exclusive Grade *KKDC tuned CCT range
A-line* 3-step CCT range
 KKDC highest lumen efficacy LED

Power consumption	Supply voltage	Supply current
40W/m (12.19W/ft)	24V DC	1.67A/m (0.51A/ft)

Performance Data (3000K)

	R1	R2	R3	R4	R5	R6	R7	R8	R9	R10	R11	R12	R13	R14
A-line	95	96	94	95	94	93	95	90	75	88	95	78	95	96

	Diffused Cover	CRI	R9	Rf	Rg
A-line	2000lm/m (610lm/ft) 50lm/W	94	75		

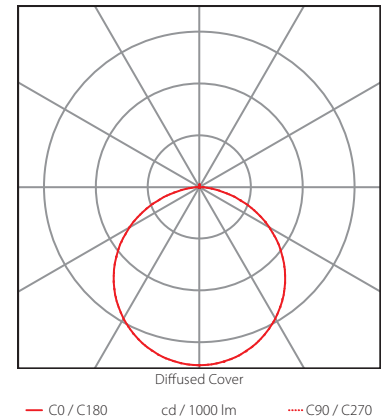
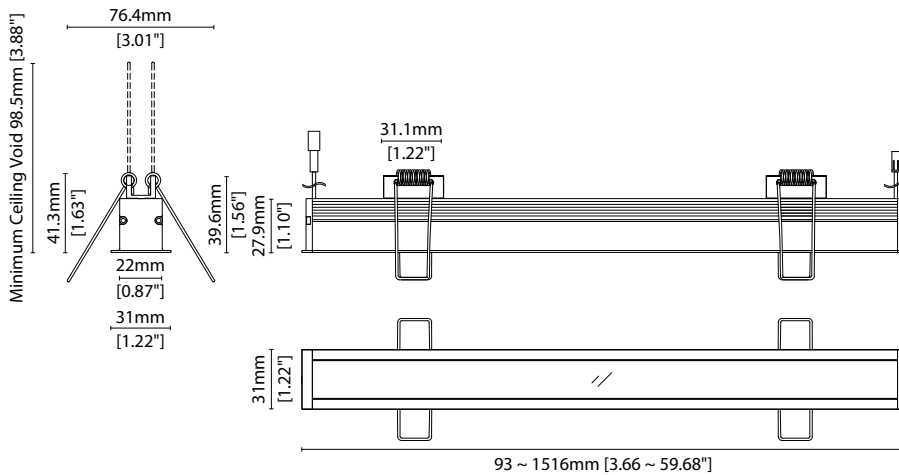

Data derived from independent UKAS / IESNA LM-79-08 accredited testing of production samples.

LINI-R XL A040 (40W)

Code Table



FIXTURE

Model	Finish	Cover/Lens ¹	Grade ²	LED	Colour (CCT)	Length Availability ³	IP	Cable Length	Power Feed	Input	
LINI-R XL	RX	Silver Anodised SA	Diffused C	A- A	A040 040	2700K 27 3000K 30 3500K 35 4000K 40	m 93-1516mm 38.46mm increments i 3.66-59.68in 1.51in increments (Specify length code OR total run length)	IP40 40	300mm/11.81" 0300 1000mm/39.37" 1000	Single no sheath tail S00X Double no sheath tail D00X Single no sheath IP20 connector S20X Double no sheath IP20 connector D20X	DC 24V g

¹ Refer to **Cover/Lens Options** on **Options** pages

² Refer to **LED Grading Key** on **Specification sheet** page

³ Refer to **Length Availability List** or enter total run length instead of length code

Code Example:

RX	-	SA	-	C	-	A	-	040	-	30	-	m	516	-	40	-	0500	-	S00X	-	g
LINI-R XL		Silver Anodised		Diffused		A-		A040		3000K		516mm		IP40		500mm (19.69in)		Single no sheath tail		DC 24V	

ACCESSORIES

Connection Accessories

KKCN-01	2 PIN male & female 50mm/1.97" pair
KKCN-03	2 PIN male & female 300mm/11.81" pair
KKCN-06	2 PIN 300mm/11.81" extension lead

PSU/Driver

0-10V/1-10V/DALI/DMX

* Refer to **Driver/PSU Options** page for details or provide requirement and KKDC to offer the suitable option

* Refer to **Power feed** on **Accessories** pages

LED ENGINE VARIANTS (LED STRIP TYPE)

Colour	LED	Lumen/m	Lumen/ft	W/m	W/ft	Spec Doc	Length	Increment
Single CCT	R007	265	81	7	2.13	LINI-R XL R007	99-2016mm (3.89-79.37in)	41.7mm (3.28in)
	R014	534	163	14	4.27	LINI-R XL R014	99-2016mm (3.89-79.37in)	41.7mm (3.28in)
	R020	731	223	20	6.10	LINI-R XL A020	99-2016mm (3.89-79.37in)	41.7mm (3.28in)
	A040	2000	610	40	12.2	LINI-R XL A040	93-1516mm (3.66-59.68in)	38.46mm (1.51in)
Warm Dim/Dynamic White	R207	594	181	16	4.88	LINI-R XL R207	99-2016mm (3.89-79.37in)	83.3mm (3.28in)
RGB	501	Red 61 Green 132 Blue 22 RGB 192	Red 19 Green 40 Blue 7 RGB 59	15.6	4.75	LINI-R XL RGB	99-2016mm (3.89-79.37in)	83.3mm (3.28in)
RGBW	R201	441	134	20	6.10	LINI-R XL RGBW	141-2016mm (5.55-79.37in)	62.5 (2.46in)

* Performance data: A/s-line, diffused cover, 3000K

Linear

LINE-R XL A040 (40W)

Length Availability List



Length Code		Fixture Length ¹		LED Strip ²		End Cap Dimension ³		Wattage (W)	Output (lm)
Metric	Imperial(US)	Metric	Imperial(US)	Metric	Imperial(US)	Metric	Imperial(US)		3000K (Test Data)
m0093	i0004	93mm	3.66in	77mm	3.03in	11mm	0.43in	3.08	206
m0131	i0005	131mm	5.18in	115mm	4.55in	11mm	0.43in	4.62	309
m0170	i0007	170mm	6.69in	154mm	6.06in	11mm	0.43in	6.16	413
m0208	i0008	208mm	8.20in	192mm	7.57in	11mm	0.43in	7.70	516
m0247	i0010	247mm	9.72in	231mm	9.09in	11mm	0.43in	9.23	619
m0285	i0011	285mm	11.23in	269mm	10.60in	11mm	0.43in	10.77	722
m0324	i0013	324mm	12.75in	308mm	12.12in	11mm	0.43in	12.31	825
m0362	i0014	362mm	14.26in	346mm	13.63in	11mm	0.43in	13.85	928
m0401	i0016	401mm	15.78in	385mm	15.15in	11mm	0.43in	15.39	1031
m0439	i0017	439mm	17.29in	423mm	16.66in	11mm	0.43in	16.93	1134
m0478	i0019	478mm	18.80in	462mm	18.17in	11mm	0.43in	18.46	1237
m0516	i0020	516mm	20.32in	500mm	19.69in	11mm	0.43in	20.00	1340
m0555	i0022	555mm	21.83in	539mm	21.20in	11mm	0.43in	21.54	1443
m0593	i0023	593mm	23.35in	577mm	22.72in	11mm	0.43in	23.08	1546
m0631	i0025	631mm	24.86in	615mm	24.23in	11mm	0.43in	24.62	1649
m0670	i0026	670mm	26.37in	654mm	25.75in	11mm	0.43in	26.16	1753
m0708	i0028	708mm	27.89in	692mm	27.26in	11mm	0.43in	27.70	1856
m0747	i0029	747mm	29.40in	731mm	28.77in	11mm	0.43in	29.23	1959
m0785	i0031	785mm	30.92in	769mm	30.29in	11mm	0.43in	30.77	2062
m0824	i0032	824mm	32.43in	808mm	31.80in	11mm	0.43in	32.31	2165
m0862	i0034	862mm	33.95in	846mm	33.32in	11mm	0.43in	33.85	2268
m0901	i0035	901mm	35.46in	885mm	34.83in	11mm	0.43in	35.39	2371
m939	i0037	939mm	36.97in	923mm	36.34in	11mm	0.43in	36.93	2474
m978	i0038	978mm	38.49in	962mm	37.86in	11mm	0.43in	38.46	2577
m1016	i0040	1016mm	40.00in	1000mm	39.37in	11mm	0.43in	40.00	2680
m1055	i0042	1055mm	41.52in	1039mm	40.89in	11mm	0.43in	41.54	2783
m1093	i0043	1093mm	43.03in	1077mm	42.40in	11mm	0.43in	43.08	2886
m1131	i0045	1131mm	44.55in	1115mm	43.92in	11mm	0.43in	44.62	2989
m1170	i0046	1170mm	46.06in	1154mm	45.43in	11mm	0.43in	46.16	3093
m1208	i0048	1208mm	47.57in	1192mm	46.94in	11mm	0.43in	47.70	3196
m1247	i0049	1247mm	49.09in	1231mm	48.46in	11mm	0.43in	49.23	3299
m1285	i0051	1285mm	50.60in	1269mm	49.97in	11mm	0.43in	50.77	3402
m1324	i0052	1324mm	52.12in	1308mm	51.49in	11mm	0.43in	52.31	3505
m1362	i0054	1362mm	53.63in	1346mm	53.00in	11mm	0.43in	53.85	3608
m1401	i0055	1401mm	55.15in	1385mm	54.52in	11mm	0.43in	55.39	3711
m1439	i0057	1439mm	56.66in	1423mm	56.03in	11mm	0.43in	56.93	3814
m1478	i0058	1478mm	58.17in	1462mm	57.54in	11mm	0.43in	58.46	3917
m1516	i0060	1516mm	59.69in	1500mm	59.06in	11mm	0.43in	60.00	4020

¹ Actual total overall length of light fixture (LED strip + end caps + void/wire hole)

² Actual length of PCB strip

³ Actual length of 2x end caps

Linear

LINI-R XL A040 (40W)

Length Availability List

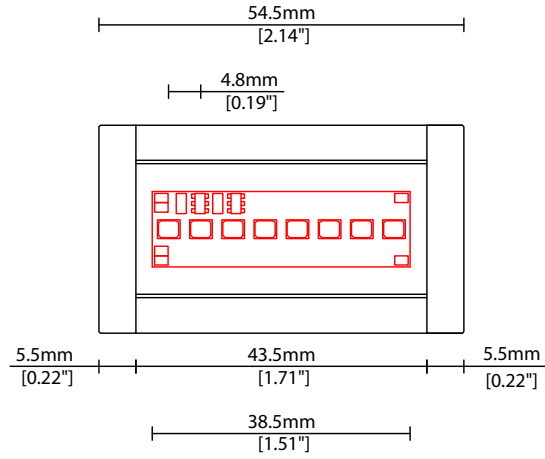



LINI-R XL A040 (40W) Options



COVER/LENS OPTIONS

* Options are an integral part of the fixture ordering codes. Please refer to **Code Table** pages.

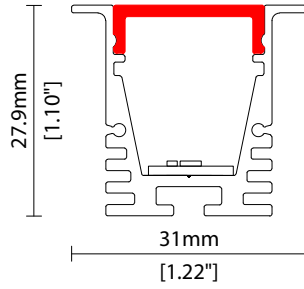

C Diffused cover

W31/H27.9mm (W1.22/H1.10")

POWER FEED OPTIONS

0300 S00X 300mm (11.81") Single no sheath tail

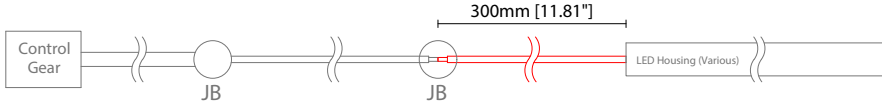

0300 D00X 300mm (11.81") Double no sheath tail

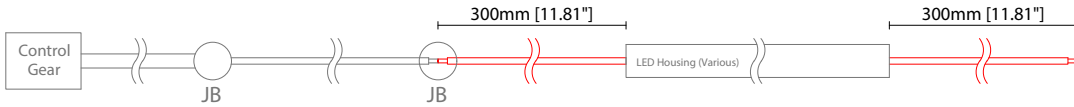

0300 S20X 300mm (11.81") Single no sheath IP20 connector

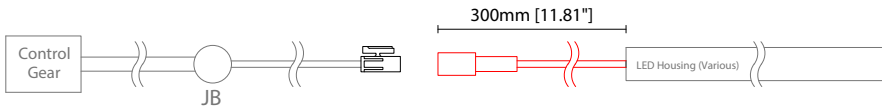

0300 D20X 300mm (11.81") Double no sheath IP20 connector

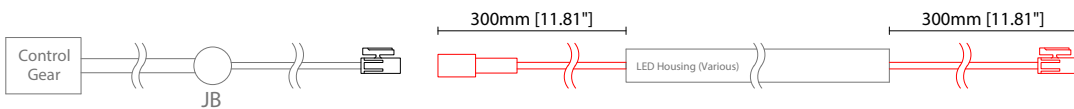

1000 S00X 1000mm (39.37") Single no sheath tail

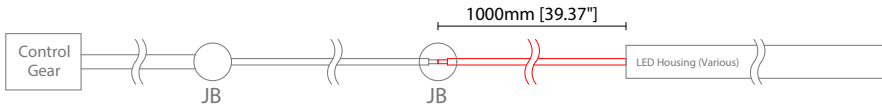

1000 D00X 1000mm (39.37") Double no sheath tail

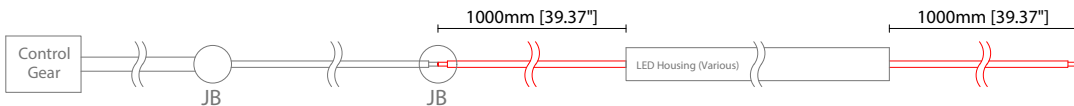

1000 S20X 1000mm (39.37") Single no sheath IP20 connector

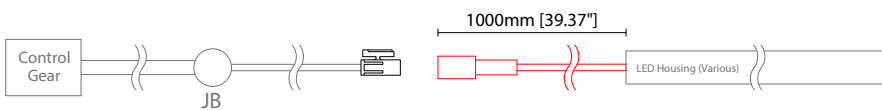

1000 D20X 1000mm (39.37") Double no sheath IP20 connector

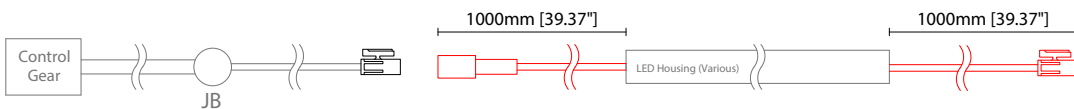

Key

Control Gear Power supply, sub-controllers & control systems
 JB Junction box / cable connection

Linear

LINI-R XL A040 (40W)

Options



POWER FEED OPTIONS (CONTINUED)

2 Pin Female Connector

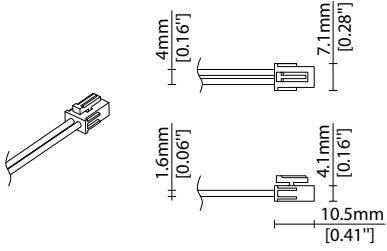

2 Pin Male Connector

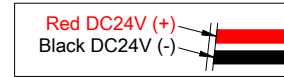
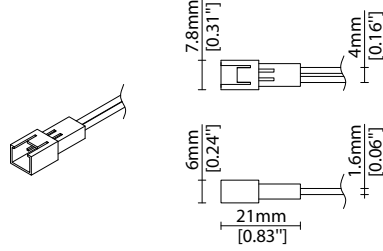

Linear

LINI-R XL A040 (40W)

Accessories

KKDC

POWER FEED

Note: Accessories are to be ordered separately with corresponding code shown below.

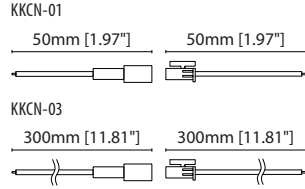
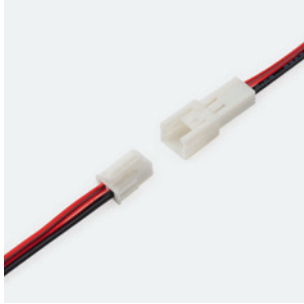

KKCN-01 50mm (1.97in) pair
KKCN-03 300mm (11.81in) pair
2 PIN male + female connector set

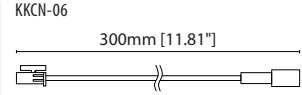

KKCN-06
2 PIN 300mm (11.81in) extension lead

KKDC CONTROL



IP20
Plastic housing
L170/W59/H29mm
(L6.69/W2.32/H1.14in)

KKDM-06 1-10V
visDIM dimmable sub-controller
(4 x 8A max @ 12-36V)



IP20
Plastic housing
L170/W53.4/H28mm
(L6.69/W2.10/H1.10in)

KKSC-05 DMX
visDIM dimmable sub-controller
(4 x 5A max @ 12-36V)



IP20
Plastic housing
L170/W59/H29mm
(L6.69/W2.32/H1.14in)

KKDL-02 DALI
visDIM dimmable sub-controller
(4 x 8A max @ 12-36V)



IP20
Plastic housing
L166/W53.4/H23mm
(L6.54/W2.10/H0.91in)

KKDL-03 DALI
visDIM dimmable sub-controller
(4 x 5A max @ 12-36V)

AVAILABLE PSU OPTIONS

Control Mode	PSU (Order Code)	Input Voltage AC	Output Voltage DC	Rated Output Current	Rated Power	Dim %	IP Rating
Switched	CEN-60-24	90-295V	24V	2.5A	60W	-	IP67
	HLG-60H-24	90-305V	24V	2.5A	60W	-	IP67
	HLG-100H-24	90-305V	24V	4.0A	100W	-	IP67
	HLG-150H-24	90-305V	24V	6.3A	150W	-	IP67
	HLG-240H-24	90-305V	24V	10A	240W	-	IP67
0-10V (1-10V)	PWM-40-24	90-305V	24V	1.67A	40W	100-0.15 (100-10)	IP67
	PWM-60-24	90-305V	24V	2.5A	60W	100-0.15 (100-10)	IP67
	PWM-90-24	90-305V	24V	3.67A	90W	100-0.15 (100-10)	IP67
	PWM-120-24	90-305V	24V	5.0A	120W	100-0.15 (100-10)	IP67
DALI	LIN100A1	120-277V	24V	1A per channel	100W	100-0.1	IP66/IP40
DMX RGB	LIN100A1	120-277V	24V	1.33A per channel	100W	100-0.1	IP66/IP40
DMX RGBW	LIN100A1	120-277A	24V	1A per channel	100W	100-0.1	IP66/IP40

Flicker Free Options - Combination of PSU+ sub-controller

Control Mode	PSU (Order Code)	Sub-controller (Order Code)	Input Voltage AC	Output Voltage DC	Rated Output Current	Rated Power	Dim %	IP Rating PSU/ Sub-controller
0-10V or 1-10V	CEN-60-24	KKDM-06	90-295V	24V	2.5A	60W	100-0.9	IP67/IP20
	HLG-60H-24	KKDM-06	90-295V	24V	2.5A	60W	100-0.9	IP67/IP20
	HLG-100H-24	KKDM-06	90-295V	24V	4.0A	100W	100-0.9	IP67/IP20
	HLG-150H-24	KKDM-06	90-295V	24V	6.3A	150W	100-0.9	IP67/IP20
	HLG-240H-24	KKDM-06	90-295V	24V	10.0A	240W	100-0.9	IP67/IP20
DALI	CEN-60-24	KKDL-02/03	90-295V	24V	2.5A	60W	100-0.1	IP67/IP20
	HLG-60H-24	KKDL-02/03	90-305V	24V	2.5A	60W	100-0.1	IP67/IP20
	HLG-100H-24	KKDL-02/03	90-305V	24V	4.0A	100W	100-0.1	IP67/IP20
	HLG-150H-24	KKDL-02/03	90-305V	24V	6.3A	150W	100-0.1	IP67/IP20
	HLG-240H-24	KKDL-02/03	90-305V	24V	10.0A	240W	100-0.1	IP67/IP20
DMX RGB	CEN-60-24	KKSC-05	90-295V	24V	2.5A	60W	100-0.9	IP67/IP20
	HLG-60H-24	KKSC-05	90-305V	24V	2.5A	60W	100-0.9	IP67/IP20
	HLG-100H-24	KKSC-05	90-305V	24V	4A	100W	100-0.9	IP67/IP20
	HLG-150H-24	KKSC-05	90-305V	24V	6.3A	150W	100-0.9	IP67/IP20
	HLG-240H-24	KKSC-05	90-305V	24V	10.0A	240W	100-0.9	IP67/IP20

¹ The items shown above cover the most frequently used specification but does not exhaust the possible options

² PSU and/or driver can be chosen from the table, or KKDC may recommend the best option upon receipt of the controls requirement and installation environment

³ Electrical shop drawing will include detailed information of PSU and relevant control drivers

⁴ Cut sheets are available on the controls section of www.kkdc.lighting or upon request